

P R O D U C T D A T A S H E E T

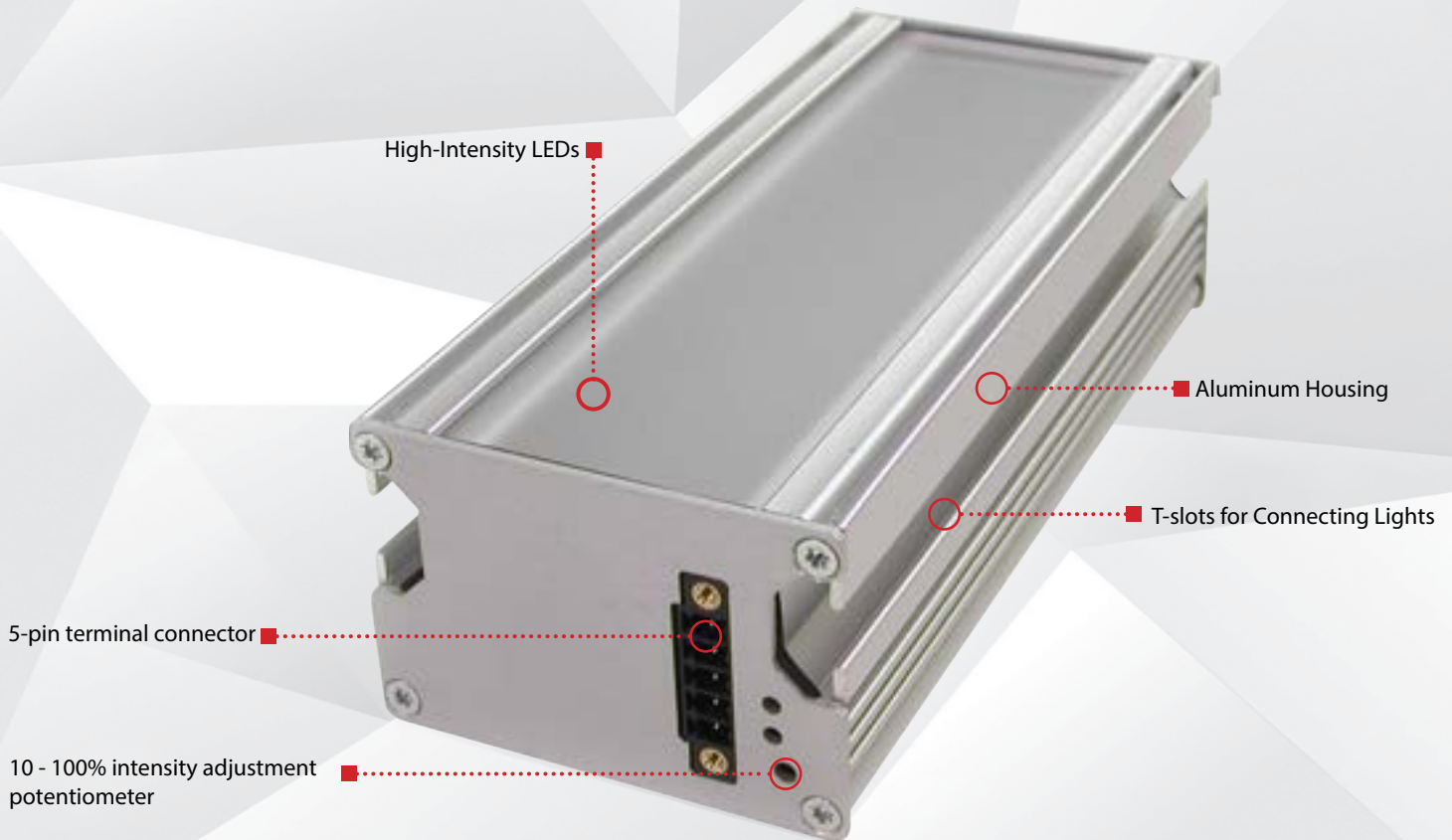

Warranty
10
YEAR

Compliant
IEC
62471

Compliant
CE
RoHS

Rated
IP
50

Terminal
Connector
5-PIN

PRODUCT HIGHLIGHTS

- ✓ Built-in driver
- ✓ PNP and NPN strobe input
- ✓ T-slot for mounting and connecting lights
- ✓ Direct connect up to 12 units

PRODUCT DESCRIPTION

The modular design of the LX150 linear light, part of the Direct Connect Linear Light Series, offers integrated light-to-light connectors, eliminating the need for cable connectors to string lights together. The light operates in continuous operation. This innovative design requires power connection to the first light but eliminates the need for jumper cables to pass power through to the next, enabling tailored-length solutions in increments of 150 mm. Direct connect up to twelve LX150 together. Compatible with the LX300.

PRODUCT SPECIFICATIONS

Electrical Input	24VDC +/- 5%
Input Current	500 mA
Wattage	12 W
On / Off Input	PNP > +4 VDC (24 VDC max.) to activate or NPN ≥ GND <1VDC to activate (not both)
PNP Trigger	4 mA @ 4VDC 10 mA @ 12VDC 20 mA @ 24VDC
NPN Trigger	15 mA @ Ground (0VDC)
Yellow Indicator LED	LED Strobe Indicator ON = Light Active
Green Indicator LED	ON = Power
Continuous Mode	NPN can be tied to ground OR PNP can be tied to 24VDC (not both).
Potentiometer	270° turn pot—intensity control of 10%–100%. Turn clockwise to increases intensity.
Analog Intensity	The output is adjustable from 10%–100% of brightness by a 1–10VDC signal. (Jumpering pin 3 to pin 1 will provide maximum intensity).
Connection	5-pin terminal connector
Ambient Temperature	-18°–40°C (0°–104°F)
IP Rating	IP50
Weight	~285g
Compliances	CE, RoHS, IEC 62471
Warranty	UV LEDs have a 2 year warranty, all other LEDs have a 10 year warranty. For complete warranty information, visit smartvisionlights.com/warranty .

WIRING CONFIGURATION

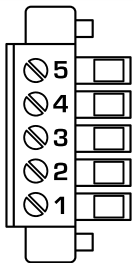

Pins	Function	Signal	Wire Color
5	GND	Ground	BLUE
4	PNP	4VDC to 24VDC for active on	BLACK
3	Intensity Control	1-10VDC	GREY*
2	NPN Strobe	GND for active ON	WHITE
1	Power	+24VDC	BROWN

OPTIONAL
For maximum intensity, it is possible to jumper pin 3 to pin 1

For maximum intensity, it is possible to tie pin 3 to pin 1 at +24VDC.

For continuous mode: PNP (pin 4) can be tied to +24VDC (pin 1) or NPN (pin 2) can be tied to ground (pin 5).

Pin layout for light (Male Connector)



RESOURCE CORNER

Additional resources are available on our website, including CAD files, videos, and application examples.



LIGHT PATTERNS

Smart Vision Lights recommends the LX150 be used at a working distance between 300 mm to 4000 mm.

Beam Diameter (White Light) — 5,700 K

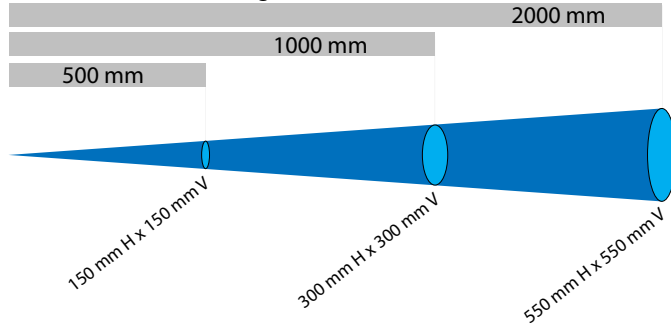

Beam Diameter (White Light) — 5,700 K

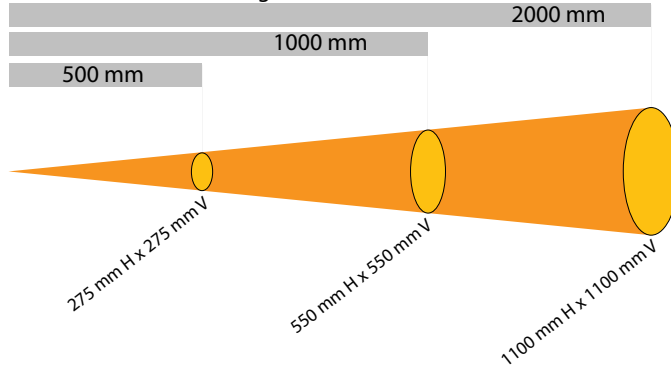

Beam Diameter (White Light) — 5,700 K

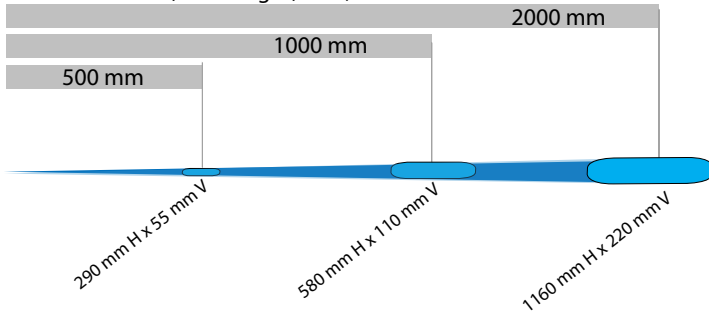

LIGHTING PATTERN FOR THE LX150 with Narrow (Standard) Lenses

Working Distance mm (inches)	Pattern (80%–100% measured intensity) mm (inches)
500 mm (19.7")	150 mm (~5.9") H x 150 mm (~5.9") V
1000 mm (39.4")	300 mm (~11.8") H x 300 mm (~11.8") V
2000 mm (78.8")	550 mm (~21.6") H x 550 mm (~21.6") V

Typical Output Performance	Illuminance (Lux)
Distance = 500 mm	11,000
<i>Illuminance measurement taken on White Lights — 5,700 K</i>	

LIGHTING PATTERN FOR THE LX150 with Wide (W) Lenses

Working Distance mm (inches)	Pattern (80%–100% measured intensity) mm (inches)
500 mm (19.7")	275 mm (~10.8") H x 275 mm (~10.8") V
1000 mm (39.4")	550 mm (~21.6") H x 550 mm (~21.6") V
2000 mm (78.8")	1100 mm (~43") H x 1100 mm (~43") V

Typical Output Performance	Illuminance (Lux)
Distance = 500 mm	8,000
<i>Illuminance measurement taken on White Lights — 5,700 K</i>	

LIGHTING PATTERN FOR THE LX150 with Line (L) Lenses

Working Distance mm (inches)	Pattern (80%–100% measured intensity) mm (inches)
500 mm (19.7")	290 mm (~12.2") H x 55 mm (~2.1") V
1000 mm (39.4")	580 mm (~24.4") H x 110 mm (~4.3") V
2000 mm (78.8")	1160 mm (~48.8") H x 220 mm (~8.6") V

Typical Output Performance	Illuminance (Lux)
Distance = 500 mm	19,000
<i>Illuminance measurement taken on White Lights — 5,700 K</i>	

The LX150 Linear Light produces a uniform light pattern.

Working Distance = 500 mm Grid set to 25 mm x 25 mm

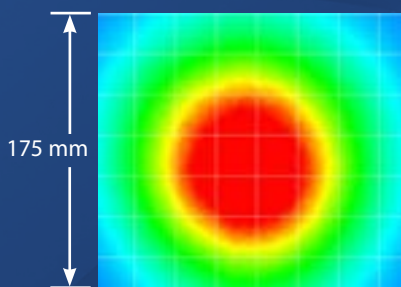

Narrow

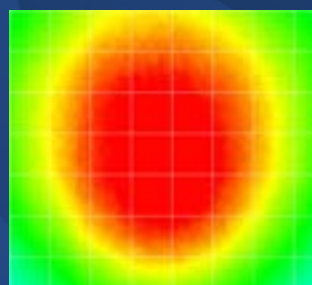

Wide

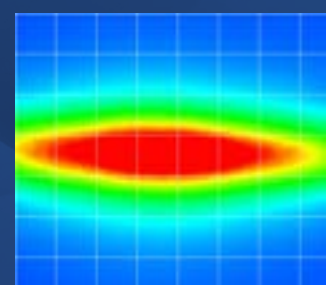

Line

PRODUCT DRAWING

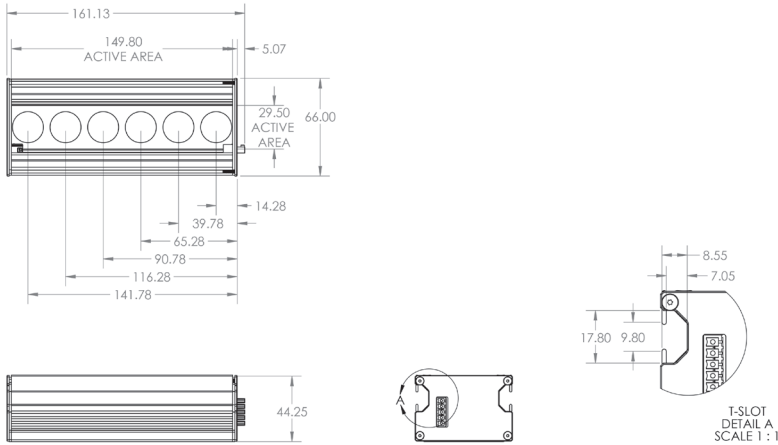

DIRECT-CONNECT LIGHTS

LX150 Series of lights requires the use of LXJ-2DTN connectors to effectively daisy-chain lights together.



ILLUMINATION

LX150 Series of Linear Lights works best for:

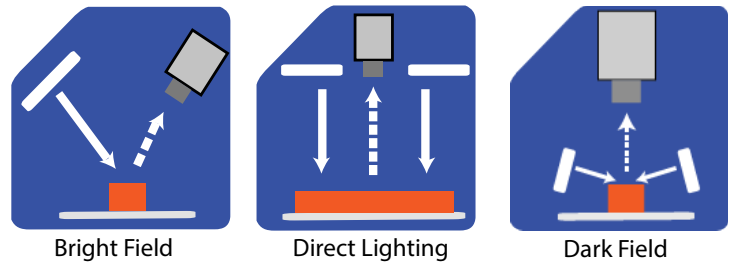

EYE SAFETY

According to IEC-62471:2006. Full documentation available upon request.



Notice

Exempt Group: No photobiological hazard to eyes or skin even for continuous, unrestricted use. Applicable for wavelengths 625, 850, 940, 1050, 1200, 1300, 1450, and 1550.

Caution

Risk Group 1: Possibly hazardous optical radiation emitted from this product. Do not stare at operating lamp. May be harmful to eyes. Safe for most applications except prolonged exposure. Applicable for wavelengths: 470, 505, 530, and WHI.

Warning

Risk Group 3: UV emitted from this product. Eye or skin irritation may result from exposure. Use appropriate shielding. Does not pose optical hazard if aversion responses limit exposure. Applicable for wavelengths: 365 and 395



PART NUMBER

LX150



COLOR:



LENS:

Leave blank for standard (narrow)

W = Wide (30°)

L = Line (10° x 50°)



LINEAR POLARIZER:

Leave blank for none

LPI = Factory Installed

Part Number Examples:

LX150-625 LX150, 625 nm Red Wavelength, Standard (Narrow) Lenses

LX150-WHI-L LX150, White, Line Lenses

LX150-470-W-LPI LX150, 470 nm Blue Wavelength, Wide Lenses, with Linear Polarizer installed

* Line lens optic not available for UV wavelengths.

Additional wavelengths and lens options available upon request.



LENS OPTICS

NARROW (STANDARD)

Narrow lenses are standard.

Narrow, 14° angle-cone lenses are standard. Standard lenses project a narrow beam of illumination and are used for long working distances.

WIDE

Wide, 30° angle-cone lenses project a large area of illumination. They create a floodlight effect, can be used for short working distances.

LINE

Line, with a 10° width and a 50° fan angle projects a thin, narrow beam of illumination.

* Additional lens options available upon request.

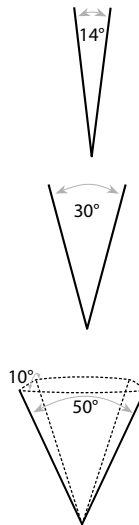

When to Use a Linear Polarizers?

Polarizing filters can reduce reflections on specular surfaces.

A Linear Polarizer has a typical transmission of 38 percent while blocking 62 percent of the light not in the polarization plane.

WARNING: Running a light in continuous operation while using a standard polarizer with certain wavelengths (e.g., white, blue) may burn the polarizer.



ACCESSORIES

Connector (Only for Direct Connect)	
	
Description	Part Number
Set of 2 Connectors	LXJ-2DTN

No Direct Connect End Cap	
	
Description	Part Number
No Direct Connect End Cap	PLT0146-CLR

Replacement Terminal Block Plugs	
	
Description	Part Number
Male to female terminal block connectors	LX-2CON-KIT

Power Connector	
	
Length	Part Number
300 mm	5PM12-LXP



GLOSSARY

This glossary covers all Smart Vision Lights product families; some content in this section may not apply to this specific light.

TERMINOLOGY

OverDrive™ Lights include an integrated high-pulse driver for complete LED light control.

Continuous Operation Lights stay on continuously.

Multi-Drive™ Combines continuous operation and OverDrive™ strobe (high-pulse operation) mode into one easy-to-use light.

Built-In Driver The built-in driver allows full function without the need for an external controller.

Camera to Light Connect the light directly to the camera, without the need for additional controllers or equipment.

Polarizers Filters that reduce reflections on specular surfaces.

Diffuser Used to widen the angle of light emission, reduce reflections, and increase uniformity.

TYPES OF ILLUMINATION

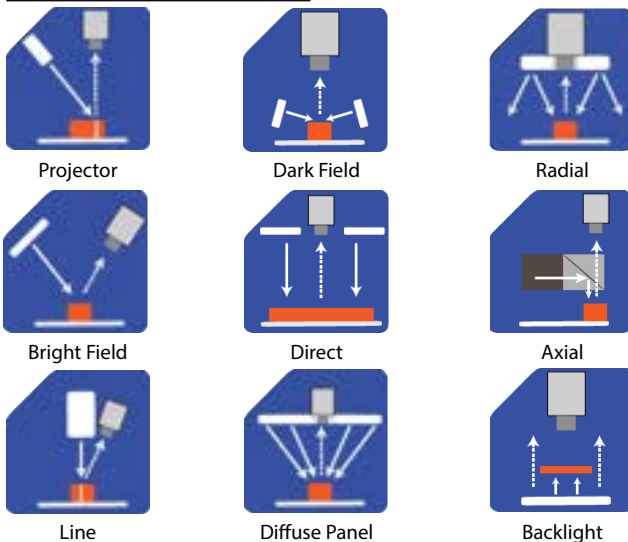

COMMON COLOR/WAVELENGTHS LEGEND

Wavelength options range from 365 nm to 1550 nm.*
Additional wavelengths available for many light families.

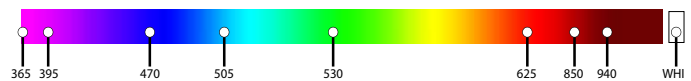

*See Part Number section for **this light's** available standard wavelengths.



Shortwave infrared LEDs are available in 1050 nm, 1200 nm, 1300 nm, 1450 nm, and 1550 nm.*

*Check Part Number section to see if **this light** is available in SWIR wavelengths.