

# R130 Ring Light EZ MOUNT

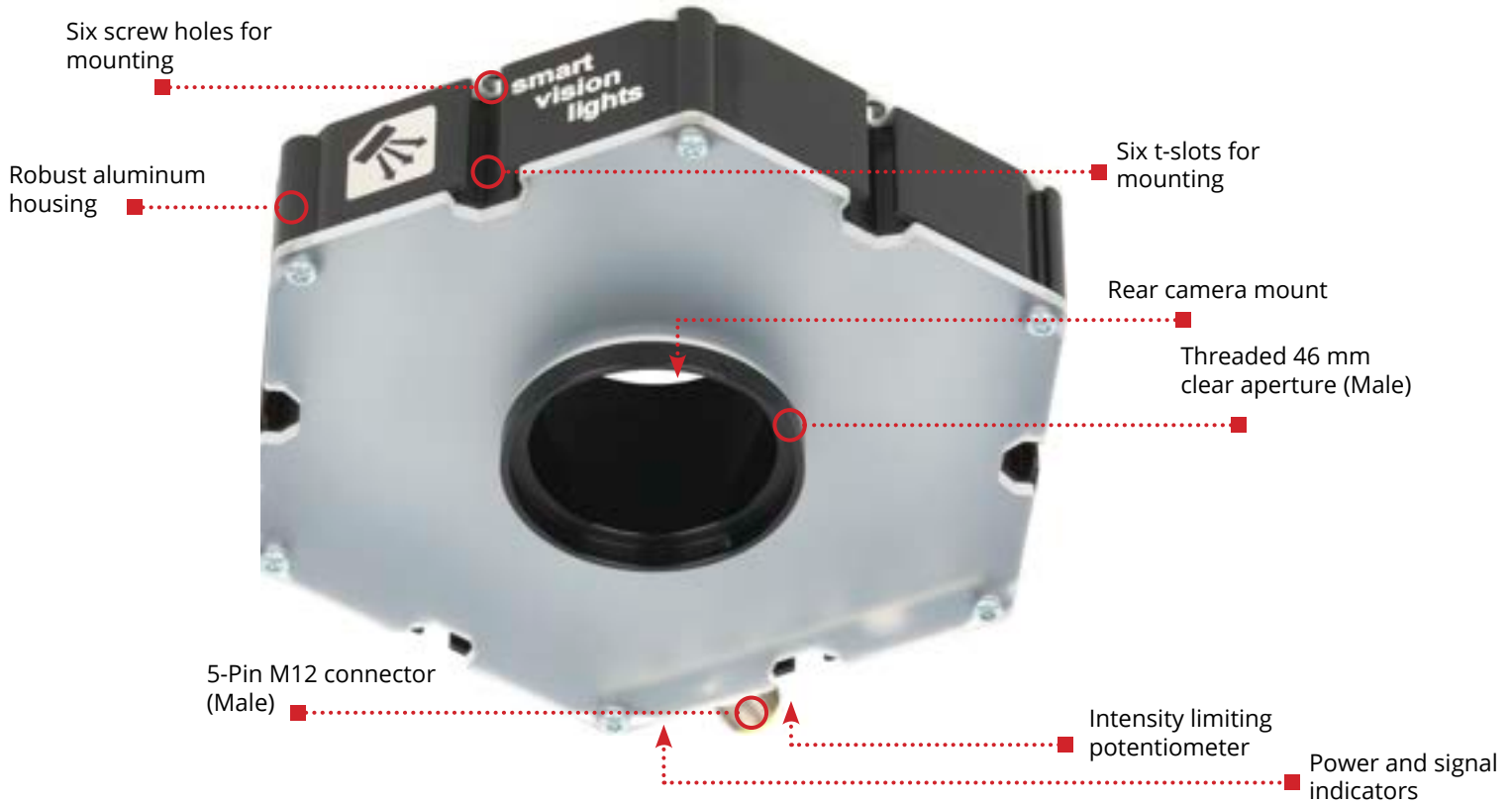

The R130 is an all-around durable light. The 10%-100% intensity limit control gives users full control over light output. A standard 42 mm inner hole diameter allows for use with nearly all camera systems with available step-up and step-down conversion kit adapters.

## R130 HIGHLIGHTS

Warranty <b>10 YEAR</b>	Tested <b>IEC 62471</b>	Compliant <b>CE ROHS</b>	Rated <b>IP 50</b>	Connector <b>5-PIN M12</b>
--------------------------------	--------------------------------	---------------------------------	---------------------------	-----------------------------------

- ✓ Compact aluminum housing
- ✓ Built-in status indicators
- ✓ Built-in potentiometer
- ✓ T-slots for easy mounting

## SPECIFICATIONS

Electrical Input	24 VDC +/- 5%
Input Current	Max. 500 mA
Input Power	Max. 12 W
PNP Trigger	2.8 mA @ 4VDC   8.8 mA @ 12VDC   17.6 mA @ 24VDC
NPN Trigger	14.4 mA @ Common (0VDC)
Trigger Input	PNP > +4 VDC (24 VDC max.) to activate <b>or</b> NPN ≥ GND <1VDC to activate ( <b>not both</b> )
Strobe Duration	Min. 30 μs   Max. ∞
Strobe Trigger Latency	10 μs
Power Indicator	Turns green when powered up
Status Indicators	Strobe indicator will turn yellow when on
Intensity Limit	270° turn-pot. Turn clockwise to increase intensity limit.
Analog Intensity	The output is adjustable from 10% - 100% of intensity limit by a 1 - 10 VDC signal. Jumpering pin 5 to pin 1 will provide maximum intensity
Connection	5-pin M12 connector
Operating Temperature	-10° to 40° C (14° to 104° F)   RH max 80% non-condensing humidity
Storage Temperature	-20° to 70° C (-4° to 158° F)   RH max 80% non-condensing humidity
IP Rating	IP50
Weight	~0.7 lbs   ~325 g
Compliances	CE, IEC 62471, RoHS
Warranty	10 years <sup>1</sup>

<sup>1</sup>See [SmartVisionLights.com/warranty](http://SmartVisionLights.com/warranty) for details

## WIRING CONFIGURATION

### CONTINUOUS OPERATION MODE

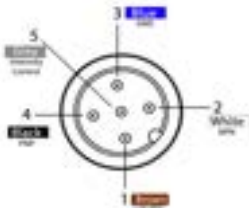

Pin layout for light (Male Connector)

Pins	Function	Signal	Wire Color
1	Power In	+24VDC	BROWN
2	NPN	Sinking Signal	WHITE
3	GND	Ground	BLUE
4	PNP	Sourcing Signal	BLACK
5	Intensity Control	1-10VDC	GREY*

For maximum intensity, tie pin 5 to pin 1 at +24VDC.

For continuous mode: PNP (pin 4) can be tied to +24 V DC (pin 1) **or** NPN (pin 2) can be tied to Ground (pin 3).

For proper light function, apply either a PNP or NPN signal, not both.

Failure to supply light with correct input current will result in inconsistent lighting behavior.

(see Product Specifications for requirements)

## LIGHTING PATTERNS

The R130 is recommended to be used at a working distance between 200 mm to 1000 mm. Illuminance values taken on white light - 5700K

### Narrow (14°) lighting patterns



### Standard (30°) lighting patterns

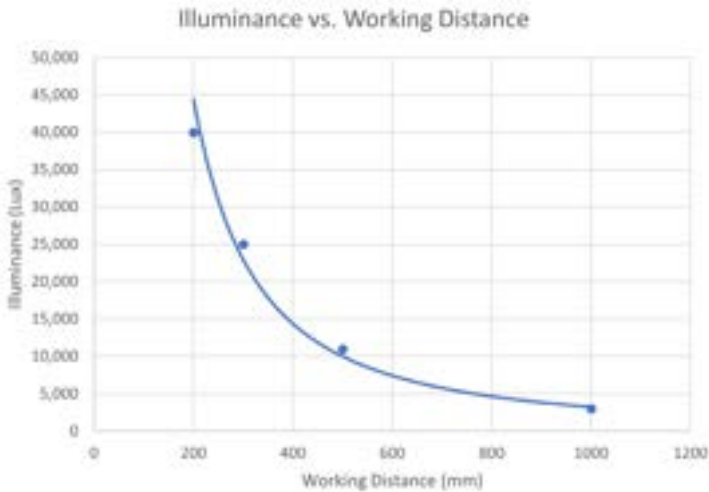

## BEAM PATTERNS

The R130 is recommended to be used at a working distance between 200 mm to 1000 mm. Illuminance values taken on white light - 5700K

### Narrow (14°) beam patterns

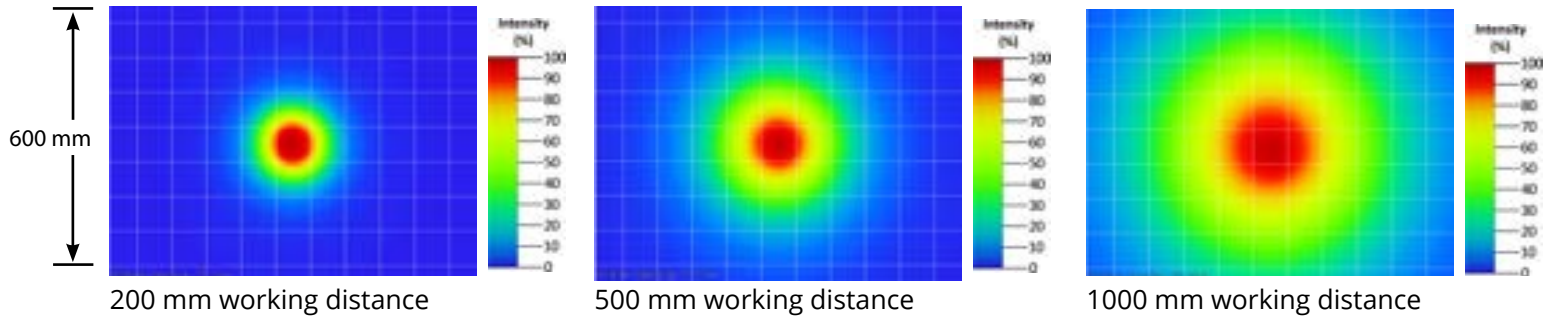

### Standard (30°) beam patterns

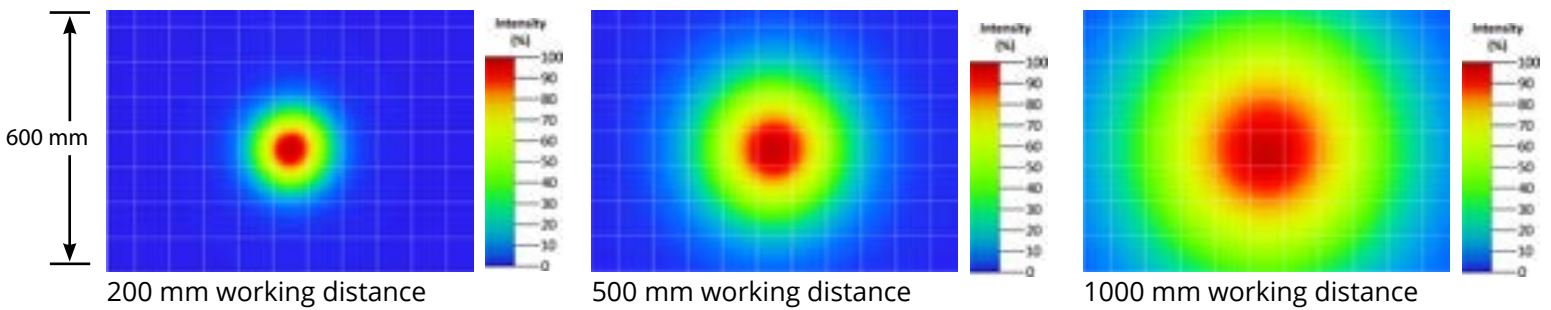

## LENS OPTICS

### NARROW

Narrow, 14° angle-cone lenses project a narrow beam of illumination and are used for long working distances.



### WIDE (STANDARD)

Wide, 30° angle-cone lenses are standard. They project a large area of illumination. They create a floodlight effect, can be used for short working distances.

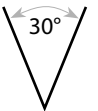

## MOUNTING

Mounting options on the R130 EZ Mount Ring Light include six T-slots and six M4 threaded holes.

### Optional Mounting Hardware:

T-slots = M5 x 0.8 mm T-nut

Threaded screw holes = M4 screws

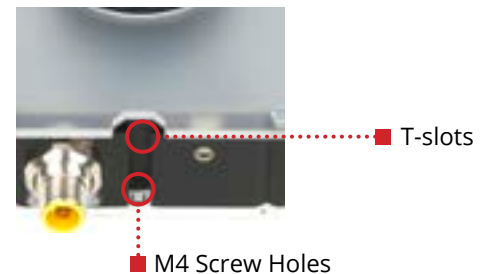

## CAMERA MOUNTING ADAPTERS

When mounting a camera directly on to an EZ Mount Ring Light, a Double Female (DF) threaded camera adapter is used.

See page 7 for ordering information.

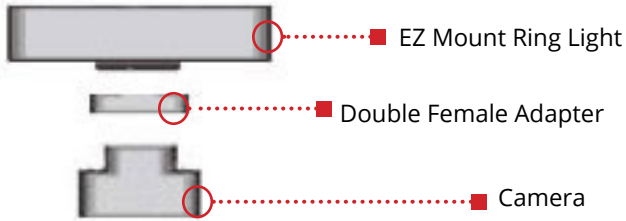

## STEP-UP / STEP-DOWN ADAPTERS

Step-Up/Step-Down Adapter Kits allow the M46 thread on ring lights to be mounted directly to the threads found on the front-end of most popular lenses.

Step-Up Adapters allow for mounting a lens that is smaller in diameter to an EZ Mount Ring Light, while Step-Down Adapters allow for mounting a larger lens to an EZ Mount Ring Light.

These kits include: a set of screws and a hex wrench.

See page 7 for ordering information.

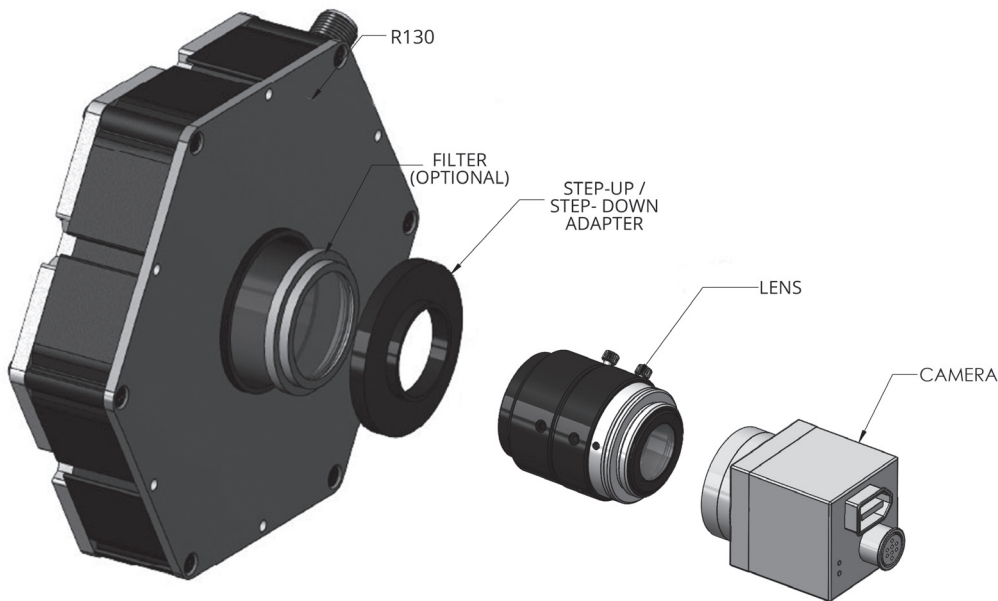

## EYE SAFETY

According to IEC 62471:2006. Full documentation available upon request with purchase of product.

### Notice

**Exempt Group:** No photobiological hazard to eyes or skin even for continuous, unrestricted use. Applicable for wavelengths 625, 850, and 940.

### Caution

**Risk Group 1:** Possibly hazardous optical radiation emitted from this product. Do not stare at operating lamp. May be harmful to eyes. Safe for most applications except prolonged exposure. Applicable for wavelengths 470, 505, 530, and WHI.

### Caution

**Risk Group 2:** UV emitted from this product. Eye or skin irritation may result from exposure. Use appropriate shielding. Applicable for wavelengths 365 and 395.

## ILLUMINATION

The R130 works best for:

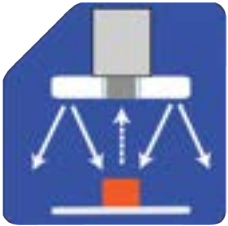

Radial

## SAFESTROBE™

SafeStrobe™ is a unique technology that applies safe working parameters to ensure high current LEDs are not damaged by driving them beyond their limits, such as maximum strobe time or duty cycle. This is especially beneficial for overdriving our high current LEDs.

## PART NUMBER GUIDE

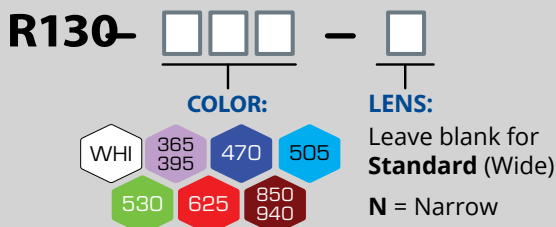

### Part Number Examples:

- R130-625** R130, 625 Red Wavelength, Standard (Wide) Lens
- R130-WHI** R130, White, Standard (Wide) Lens

## ADAPTER KITS PART NUMBERS GUIDE

### STEP-DOWN ADAPTER

**SD** –  – **46**

<p>LENS THREAD SIZE</p> <p>49 52 55 58 62 67 72</p>	<p>RING LIGHT THREAD SIZE</p>
---	-----------------------------------

### STEP-UP ADAPTER

**SU** –  – **46**

<p>LENS THREAD SIZE</p> <p>25.5 27 30.5 34 35.5 37 39 40.5 43</p>	<p>RING LIGHT THREAD SIZE</p>
---	-----------------------------------

### DOUBLE-FEMALE ADAPTER\*

**DF** –  – **46**

<p>CAMERA THREAD SIZE</p> <p>34.9 55 60</p>	<p>RING LIGHT THREAD SIZE</p>
---	-----------------------------------

\*When mounting an EZ Mount Ring Light, a double-female adapter is used.

## ACCESSORIES

Power Cables	
	
Length	Part Number
5 m	5PM12-5
10 m	5PM12-10
15 m	5PM12-15

Variable Control Pot	
	
Description	Part Number
Controls the intensity of the light	IVP-C1

Step-Up Kits *	
	
Lens Thread Size	Part Number
25.5 mm	SU25.5-46
27 mm	SU27-46
30.5 mm	SU30.5-46
34 mm	SU34-46
35.5 mm	SU35.5-46
37 mm	SU37-46
39 mm	SU39-46
40.5 mm	SU40.5-46
43 mm	SU46-46

Step-Down Kits	
	
Lens Thread Size	Part Number
49 mm	SD49-46
52 mm	SD52-46
55 mm	SD55-46
58 mm	SD58-46
62 mm	SD62-46
67 mm	SD67-46
72 mm	SD72-46

Camera Adapters	
	
Camera Thread Size	Part Number
55 mm	DF55-46
60 mm	DF60-46
34.5 mm	DF34.5-46

Linear Polarizer*	
	
Description	Part Number
Linear Polarizer Kit	R130-LP

Diffuser	
	
Description	Part Number
Diffuser Kit	R130-DKIT

\*For lights with lenses, running in continuous operation while using a linear polarizer with certain wavelengths (e.g., white, blue) may burn the polarizer. Incorrect usage of the polarizer is not covered by warranty.



# PRODUCT DRAWINGS

CAD files are available on our website. Drawings are in mm.

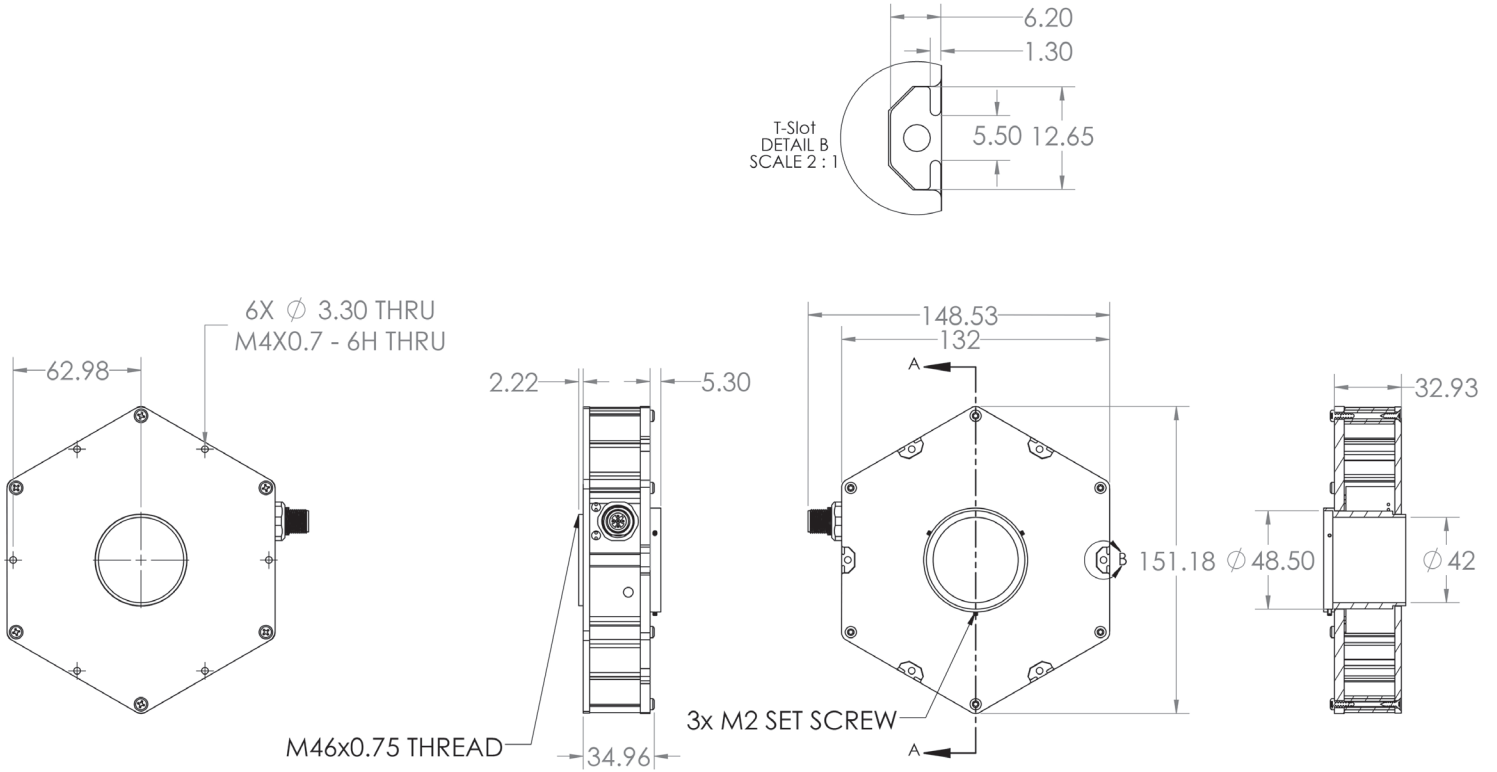

## GLOSSARY

This glossary covers all Smart Vision Lights product families; some content in this section may not apply to this specific light.

### TERMINOLOGY

**Continuous Operation** The light stays on continuously.

**OverDrive™** Integrated driver that produces a high-current strobe to the LEDs to drive them beyond their nominal continuous operation output.

**Multi-Drive™** Integrated driver that combines continuous operation and OverDrive™ strobe mode

**NanoDrive™** Integrated driver that provides fast switching where the light can go from off to on in less than 500 ns.

**Built-in Driver** The driver contained within the light that controls the current to the LEDs and provides PNP, NPN, and analog dimming controls.

**SmartVisionLink™** Integrated feature that enables lighting control through the Bluetooth module and app.

**Camera to Light** Connect the light directly to the camera, without the need for additional controllers or equipment.

**Polarizers** Filters that reduce reflections on specular surfaces.

**Diffusers** Widens the angle of emission by scattering light in all directions.

**Pattern Area Lighting** Modulated lighting pattern placed over a backlight's surface used to enhance defect detection on transparent and glossy surfaces

**SafeStrobe** Limiter to keep the light in safe working parameters.

**Direct Connect** Connect lights in a series without the use of cables.

**Daisy-Chain** Connect lights in a series with the use of cables.

### TYPES OF ILLUMINATION



Projector



Dark Field



Radial



Bright Field

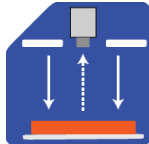

Direct

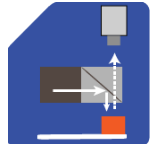

Axial

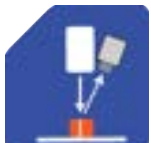

Line



Diffuse Panel

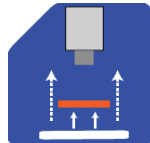

Backlight

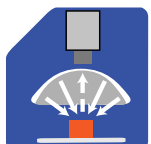

Dome  
"Light Tent"

### COMMON COLOR / WAVELENGTHS LEGEND

Wavelength options range from 365 nm to 1650 nm.\*  
Additional wavelengths available for many light families.

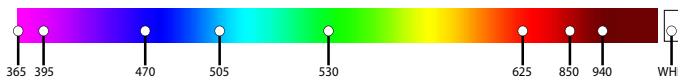

\*See Part Number section for **this light's** available standard wavelengths.



Shortwave Infrared LEDs are available in 1050 nm, 1200 nm, 1300 nm, 1450 nm, 1550 nm, and 1650 nm.\*

\*Check Part Number section to see if **this light** is available in SWIR wavelengths.

