

P R O D U C T D A T A S H E E T

T-Slots For Mounting

High Intensity LEDs

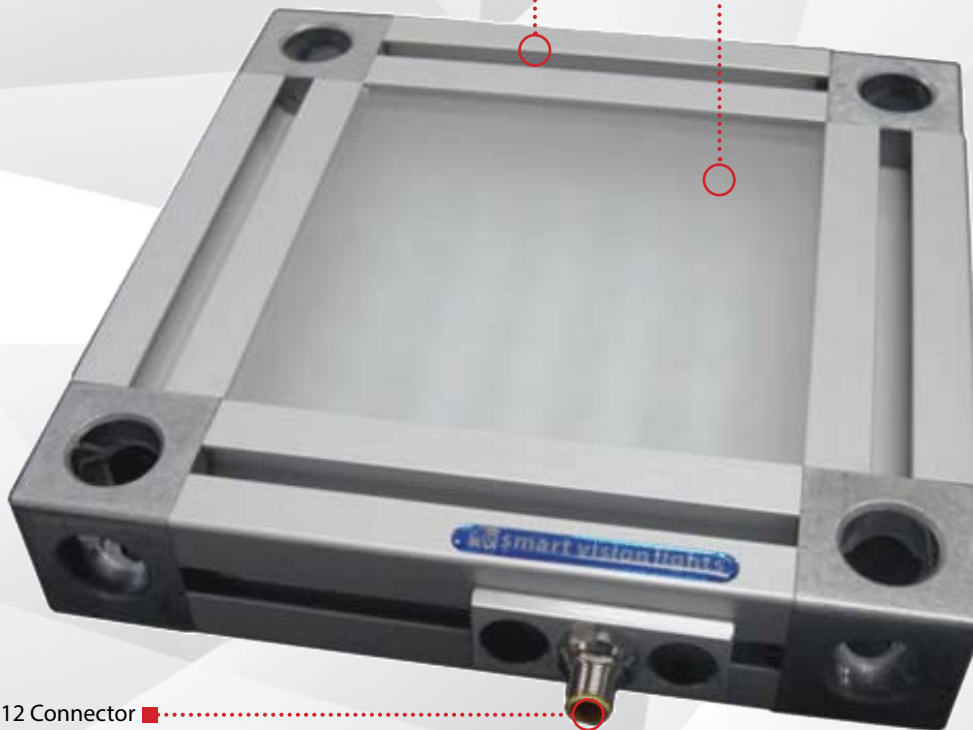

5-Pin M12 Connector  
(Male)



Warranty  
**10**  
YEAR

Tested  
**IEC**  
62471

Compliant  
**CE**  
RoHS

Rated  
**IP**  
50

Connector  
**5-PIN**  
M12

## PRODUCT HIGHLIGHTS

- ✓ OverDrive™ — Up to five times brighter than a standard Area Light
- ✓ 5-pin M12 quick connect
- ✓ SafeStrobe™ technology ensures protected operation of LEDs
- ✓ PNP and NPN trigger signal input



## PRODUCT INTRODUCTION

The ODAL Area Light is designed for OverDrive™ strobing and maximum light output. NPN or PNP trigger signal inputs can be used to control the pulse of the light. Intensity of the light can be controlled via 1–10VDC analog signal line. Proper heat dissipation is achieved using the side extrusion and backplate. The 45 mm extrusion makes mounting the light easy when using drop-in T-nuts. The ODAL Area Light has a built-in driver. No external driver is required.



## PRODUCT SPECIFICATIONS

Electrical Input	24VDC +/-5%
Strobe Input	PNP: +4VDC to +24VDC to activate   NPN: GND (<1VDC) to activate
PNP Trigger	4 mA @ 4VDC   10 mA @ 12VDC   20 mA @ 24VDC
NPN Trigger	15 mA @ Ground (0VDC)
Analog Intensity	The output is adjustable from 10%–100% of brightness by a 1–10VDC analog signal line. Jumpering pin 5 to pin 1 will provide maximum intensity.
Strobe/Pulse Time	Max. 4000 SPS (Strobes Per Second)   Max. Single Pulse = 125 ms (See SafeStrobe™ Technology for more information.)
Duty Cycle	Max. 10%
Connection	5-pin M12 connector
Ambient Temperature	-18°–40°C (0°–104°F)
IP Rating	IP50
Compliances	CE, RoHS, IEC 62471
Warranty	10 years. For complete warranty information, visit <a href="http://smartvisionlights.com/warranty">smartvisionlights.com/warranty</a> .

Standard Light Sizes	Input Current	Input Power	Weight
150 mm x 150 mm	Peak 13 A during strobe	312 W	-
300 mm x 150 mm	Peak 18 A during strobe	432 W	~3.04 kg
300 mm x 300 mm*	Peak 12 A per connector during strobe	312 W per connector	-

\*The ODAL 300 mm x 300 mm has two connectors and the input current and wattage values are listed per connector.



## WIRING CONFIGURATION

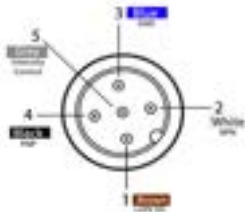

Pin layout for light (Male Connector)

Pins	Function	Signal	Wire Color
1	Power In	+24VDC	BROWN
2	NPN	Sinking Signal	WHITE
3	GND	Ground	BLUE
4	PNP	Sourcing Signal	BLACK
5	Intensity Control	1–10VDC	GREY*

\* Some cables use green/yellow for pin 5

### OPTIONAL

For maximum intensity, analog intensity may be connected to +VDC (24VDC) - Jumper pin 5 to pin 1



## RESOURCE CORNER

Additional resources are available on our website, including CAD files, videos, and application examples.



## PART NUMBER

ODAL —    X    —

SIZE:

150x150  
300x150  
300x300

COLOR:



### Part Number Examples:

ODAL-150x150-625 ODAL, 150x150, 625 Red Wavelength

The 5-pin M12 connector is located on the width side of the light.  
Sizes listed are in millimeters.  
Custom sizes available.  
Additional wavelengths options available upon request.



## LIGHT PATTERNS

Smart Vision Lights recommends the ODAL be used at a working distance between 300 mm to 4000 mm.

### LIGHTING PATTERN FOR THE ODAL

Working Distance mm (inches)	Pattern (80% - 100% measured intensity) mm (inches)
500 mm (19.7")	120 mm (~4.7") D
1000 mm (39.4")	240 mm (~9.4") D
2000 mm (78.8")	480 mm (~18.9") D

Typical Output Performance	Illumination (Lux)
Distance = 500 mm	7,600
<i>Illumination measurement taken on White Lights - 5700K</i>	

The ODAL Linear Light produces a uniform light pattern.

Working Distance = 500 mm Grid set to 25 mm x 25 mm

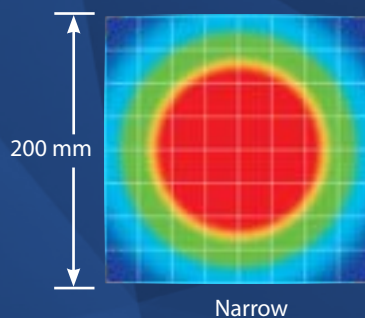

## PRODUCT DRAWING

CAD files available on our website.  
Dimensions are in mm.

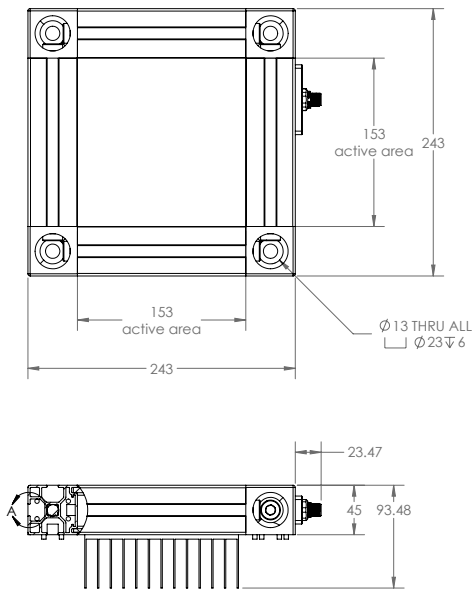

## ILLUMINATION

ODAL Series of Lights works best for:

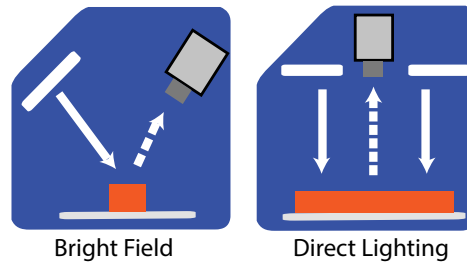

## EYE SAFETY



According to IEC 62471:2006. Full documentation available upon request.

### Notice

**Exempt Group:** No photobiological hazard to eyes or skin even for continuous, unrestricted use. Applicable for wavelengths: 625, 850, and 940.

### Caution

**Risk Group 1:** Possibly hazardous optical radiation emitted from this product. Do not stare at operating lamp. May be harmful to eyes. Safe for most applications except prolonged exposure. Applicable for wavelengths: 470, 505, 530, and WHI.

### Caution

**Risk Group 2:** UV emitted from this product. Eye or skin irritation may result from exposure. Use appropriate shielding. Does not pose optical hazard if aversion responses limit exposure. Applicable for wavelengths: 365 and 395



## DUTY CYCLE

The Duty Cycle (D) is related to the Strobe Time (ST) and Rest Time (RT).

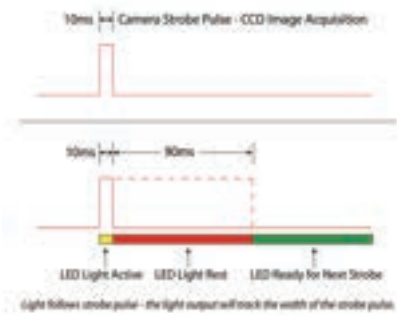

### Calculating Rest Time

$$RT = \frac{ST}{D} - ST$$

RT = Rest Time  
ST = Strobe Time  
D = Duty Cycle

#### Example

$$90 \text{ ms} = \frac{10 \text{ ms}}{.1} - 10 \text{ ms}$$

Rest Time is 90 ms for 10 ms Strobe Time

### Calculating Strobe Rate

$$SR = \frac{D}{ST}$$

SR = Strobe Rate (strokes per second)  
ST = Strobe Time (seconds)  
D = Duty Cycle

#### Example

$$1000 = \frac{0.1}{0.0001}$$

Strobe Rate is 1000 strokes per second

### Calculating Duty Cycle

$$D = ST \times SR$$

SR = Strobe Rate (strokes per second)  
ST = Strobe Time (seconds)  
D = Duty Cycle

#### Example

$$0.1 = 0.0001 \times 1000$$

Duty Cycle is 10% (0.1)

**Maximum Duty Cycle for OverDrive™ light is 10% (0.1)**

**Maximum Strobe Frequency is 1/ calculated duty cycle or 4,000 strokes per second, whichever is less.**



## MOUNTING

Smart Vision Lights recommends using drop-in T-nuts for mounting a ODAL Area Light.

### NOTE

Removing corner cubes of light may result in voiding of warranty.

Bosch size 10 T-nut channel



## ACCESSORIES

### Power Cables



Lengths	Part Number
5 m	5PM12-5
10 m	5PM12-10
15 m	5PM12-15



## GLOSSARY

This glossary covers all Smart Vision Lights product families; some content in this section may not apply to this specific light.

### TERMINOLOGY

**OverDrive™** Light includes an integrated high-current strobe driver for complete LED light control.

**Continuous Operation** Light stays on continuously.

**Multi-Drive™** Combines continuous operation and OverDrive™ strobe (high-current strobe operation) modes into one easy-to-use light.

**Built-In Driver** The built-in driver allows full function without the need of an external driver.

**Camera to Light** Connecting the light directly to the camera, without the need for additional controllers or equipment.

**Polarizers** Filters that reduce reflections on specular surfaces.

**Diffuser** Used to widen the angle of light emission, reduce reflections, and increase uniformity.

### TYPES OF ILLUMINATIONS



Projector



Dark Field



Radial



Bright Field

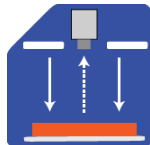

Direct

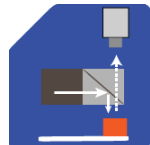

Axial



Line



Diffuse Panel

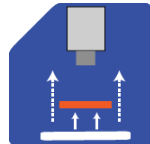

Backlight

### COLOR/WAVELENGTHS LEGEND

Wavelength options range from 365 nm to 1550 nm.  
Additional wavelengths available for many light families.

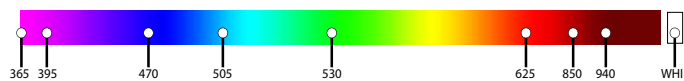

See Part Number section for **this light's** available standard wavelengths.



Shortwave infrared LEDs are available in 1050 nm, 1200 nm, 1300 nm, 1450 nm, 1550 nm, and 1650 nm.

Check Part Number section to see if **this light** is available in SWIR wavelengths.